

A1110-05-E

4-quadrant voltage and current amplifier

DC – 1 MHz | 100 V/ μ s | 500 W (source) | 150 W (sink)

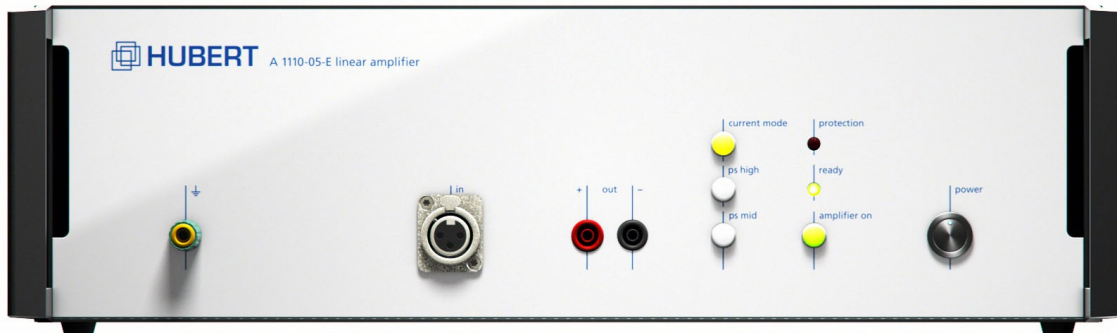

DATA SHEET

The A1110-05-E is a linear, extreme broadband precision power amplifier. It is ideally suited for applications that require fast signal processing at high power.

The A1110-05-E can be operated either as voltage amplifier or as current amplifier. In current amplifier mode it provides constant, frequency-independent output current e.g. for inductive loads.

There are three operating voltages available for optional selection: high-voltage / low-current or low-volt / high-current. Particularly with low impedance load the operating voltage can be reduced to 1/3 of the value, which entails a corresponding reduction of dissipation power.

Output voltage and output current can be optionally limited.

Moreover, low impedance signal outputs are available as monitoring outputs.

The device is equipped with a low-noise, temperature-controlled fan. In addition to over temperature shut-down, a feature for dissipation power calculation and current monitoring ensures perfect overload and short-circuit protection.

An interlock ensures optional operation as remote-controlled safety system.

Operation is performed via the control elements on the front panel of the amplifier and the graphical user interface on a PC, which is connected to the amplifier by means of the USB interface (the required software is included in the scope of delivery).

If higher output voltages or higher output currents are needed, configurations with several A1110-05-E devices connected in series or in parallel are possible.

Features

- 4-quadrant voltage and current amplifier
- Fully configurable and operable by means of the supplied software
- Output voltages up to 75 V_{peak}
- Output current up to 11 A_{peak}
- Symmetrical input
- Series / parallel input connection in case of higher voltage / current requirements
- USB port as standard (LAN interface optional)
- 3 supply voltages
- Interlock
- Voltage / current monitor output
- 6 configurable compensation networks for inductive loads in current amplifier mode

Software

The scope of delivery includes an application software that ensures fully remote-controlled operation and comprehensive configuration of the amplifier via the USB interface. In this context, disclosure of the line commands guarantee trouble-free integration of existing automated test systems.

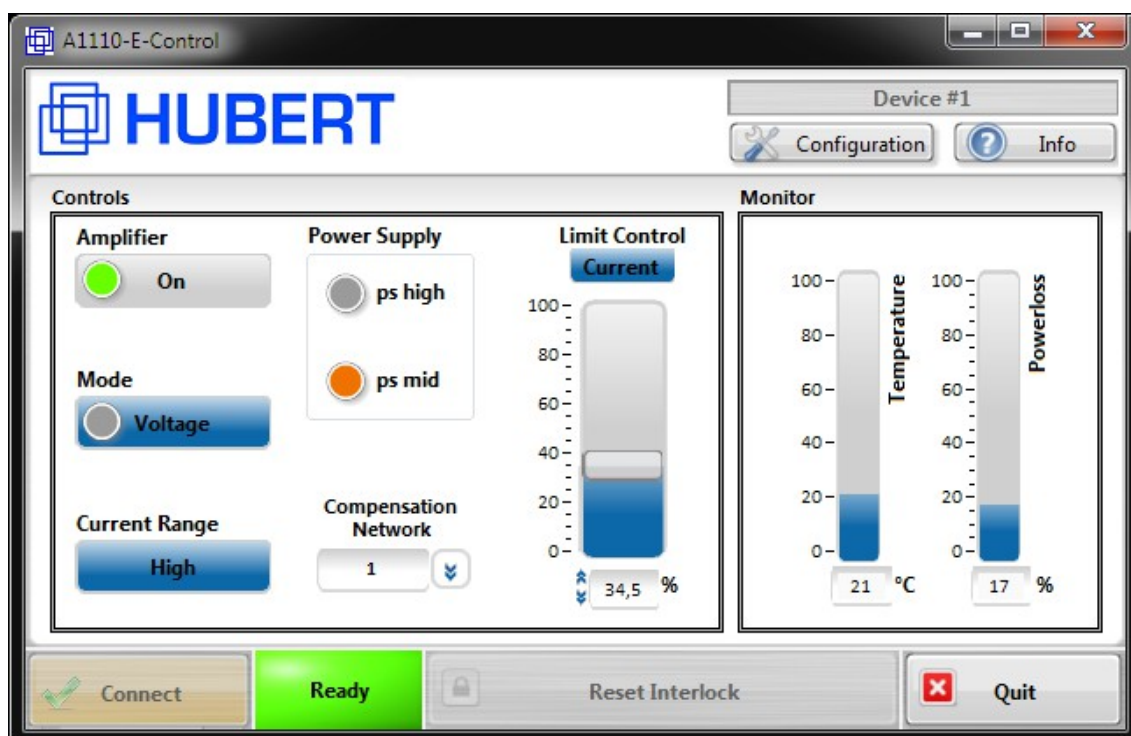

Applications

- General lab applications for research, development and testing
- EMC testing
- Material testing
- MRI
- Component tests
- Plunger coil drives
- Piezo actuation
- Generation of magnetic fields (e.g. with Helmholtz coils)
- Medical engineering
- Laser technology
- Plasma technology

Rear of the amplifier (LAN interface is optional)



Specifications

Parameters	Specification	Conditions/Moments
	Controlled Voltage Mode	25° C ambient temperature
		Continuous operation
Input Impedance	100 kOhm	unbalanced, 1kHz
	200 kOhm	balanced, 1kHz
Maximum Input Level	5.5 V (+14,5 dBV)	< 1 % THD, 1 kHz, 8 Ohm Load
Common-Mode Rejection Ratio	> 60 dB	Rs= 50 Ohm, 10 Hz – 200 kHz, re +34.5 dBV @ Output
Small Signal Frequency Response		
	DC - 200 kHz	+0, -0.5 dB, 1 W @ 8 Ohm High Voltage Mode
	DC - 1 MHz	+0, -3.0 dB, 1 W @ 8 Ohm High Voltage Mode
Phase response	+0, -5 degrees	10 Hz - 30 kHz
Power Response (continuous)		
8 Ohm Load	400 W	DC - 30 kHz, < 1% THD High Voltage Mode
	380 W	DC – 100 kHz, < 0.5% THD High Voltage Mode
	200 W	DC – 200 kHz, < 1% THD High Voltage Mode
4 Ohm Load	220 W	DC - 30 kHz, < 0.1% THD Mid Voltage Mode
	200 W	DC - 100 kHz, < 0.1% THD Mid Voltage Mode
	180 W	DC - 200 kHz, < 0.2% THD Mid Voltage Mode
3 Ohm Load	200 W	DC – 30 kHz, < 0.1% THD Mid Voltage Mode
	180 W	DC – 100 kHz, < 0.1% THD Mid Voltage Mode
	150 W	DC – 200 kHz, < 0.1% THD Mid Voltage Mode
0.5 Ohm Load	28 W	DC – 10 kHz, < 0.15% THD Low Voltage Mode
	25 W	DC – 30 kHz, < 0.2% THD Low Voltage Mode
	18 W	DC – 100 kHz, < 0.3% THD Low Voltage Mode
	15 W	DC – 200 kHz, < 0.3% THD Low Voltage Mode
Slew Rate	100 V/uSec	

Parameters	Specification	Conditions/Moments
Residual Noise		
10 Hz - 22 kHz	< 100 μ V (< -80 dBV)	All Voltage Modes Input shorted 8 Ohm Load
10 Hz - 80 kHz	< 125.5 μ V (< -78 dBV)	All Voltage Modes Input shorted 8 Ohm Load
10 Hz - 200 kHz	< 158.5 μ V (< -76 dBV)	All Voltage Modes Input shorted 8 Ohm Load
Signal-to-Noise Ratio		
10 Hz - 22 kHz	< -114.5 dB	re +34.5 dBV, < 1% THD 8 Ohm Load High Voltage Mode
10 Hz - 80 kHz	< -112.5 dB	re +34.5 dBV, < 1% THD 8 Ohm Load High Voltage Mode
10 Hz - 200 kHz	< -110.5 dB	re +34.5 dBV, < 1% THD 8 Ohm Load High Voltage Mode
THD+N		
10 Hz - 100 kHz All Voltage Modes	< 0.03 %	1 W @ 8 Ohm
Output Offset		
	< 1.0 mV	DC
Output Impedance		
	< 10 mOhm	@1 kHz; Instrument: HP8751A, Network Analyzer
Power, Pulse, 40ms, 20% Duty Cycle		
Peak output		
10 Ohm	80 V, 8 A	High Voltage Mode
5 Ohm	52 V, 10.4 A	Mid Voltage Mode
4 Ohm	43 V, 10.75 A	Mid Voltage Mode
Short-Time Current, Pulse, 500ms, 5% Duty Cycle, unipolar		
Peak Output		
60 mOhm	+ 27 A	+Ulow / -Ulow
60 mOhm	- 27 A	+Ulow / -Ulow
Power, Sinus, 100Hz, continuous		
8 Ohm	57 V, 7.125 A, 406 W	< 0.3 % THD High Voltage Mode
0.25 Ohm	1.9 V, 7.6 A, 14.4 W	< 0.1% THD Low Voltage Mode
Power, DC		
10 Ohm	72 V, 7.2 A, 518 W	High Voltage Mode
5 Ohm	47 V, 9.4 A, 442 W	Mid Voltage Mode
2 Ohm	22 V, 11 A, 242 W	Low Voltage Mode
1 Ohm	11 V, 11 A, 121 W	Low Voltage Mode
0.25 Ohm	2.7 V, 10.8 A, 29.2 W	Low Voltage Mode

Parameters	Specification	Conditions/Moments
Sink Power, DC	150 W	Low Voltage Mode; see U/I-Plot
Voltage Monitor	$\pm 100 \text{ mV} \triangleq 1 \text{ V} \pm 2\%$	
Current Monitor	High Current Range: $\pm 400 \text{ mV} \triangleq 1 \text{ A} \pm 2.5\%$	Shunt = 20 mOhm
	Low Current Range: $\pm 1.2 \text{ V} \triangleq 100 \text{ mA} \pm 1\%$	Shunt = 2.5 Ohm
Gain		
Controlled Voltage Mode	1 V / 10 V	Uin / Uout
Controlled Current Mode	High Current Range: 1 V / 1 A	Uin / Iout
	Low Current Range: n.a.	unspecified
Physical Characteristics		
AC Power	230 VAC / 50 Hz	
	USB	
Remote control	Ethernet (Option)	
Operating Temperature	10 °C to 55 °C	
Humidity	80% or less	non-condensing
Cooling	Forced air	
Dimensions (W x H x D)	449 x 133 x 495 mm	
Weight	Approx. 15 kg	

The E series amplifiers are suitable for operation at three different operating voltages:

- high operating voltage ($\pm 90 \text{ V}$) for high output voltages and low load currents
- medium operating voltage ($\pm 60 \text{ V}$) for medium output voltages and medium load currents
- low operating voltage ($\pm 30 \text{ V}$) for low output voltages and high load currents

To keep the dissipation power of the amplifier at a minimum the operating voltage should always be selected corresponding to the load.

Output Voltage vs. Frequency (THD + N < 1%)

Red: @ 8 Ohm

Blue: @ 4 Ohm

Green: @ 2 Ohm

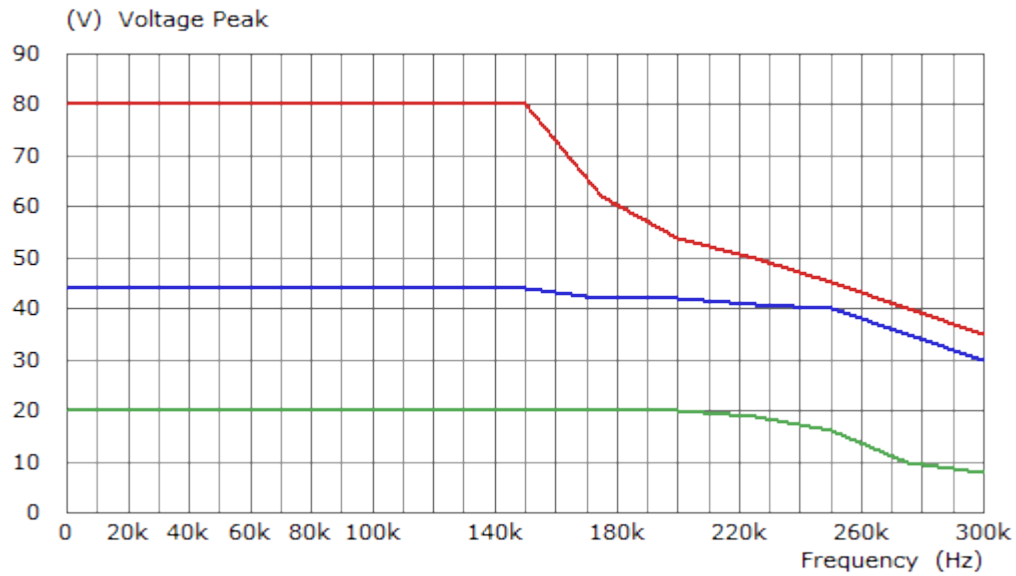

Output Current vs. Output Voltage (THD + N < 1%)

Supply Voltage: Low

Blue: AC Limit

Red: DC Limit

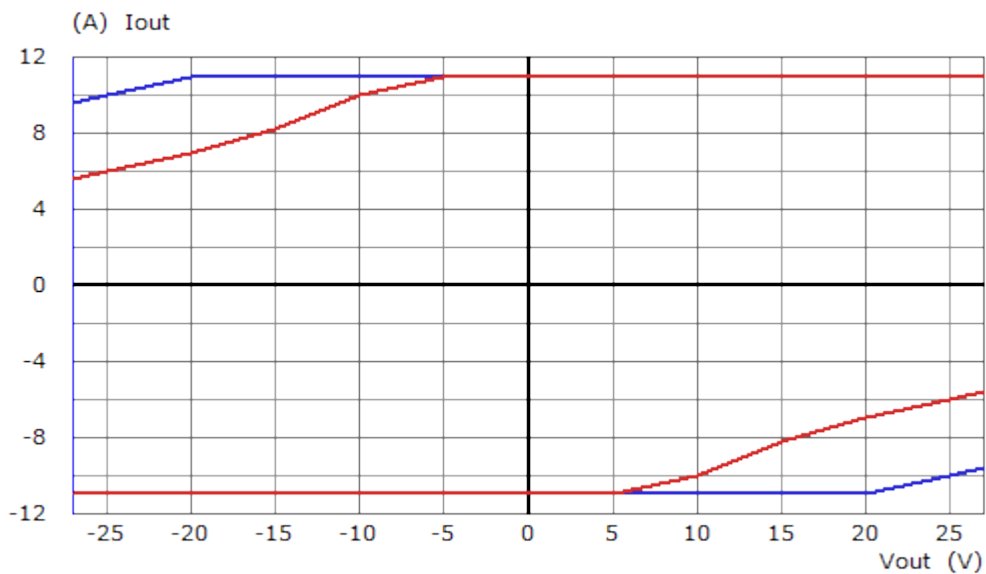

Output Current vs. Output Voltage (THD + N < 1%)
 Supply Voltage: Mid
 Blue: AC Limit
 Red: DC Limit

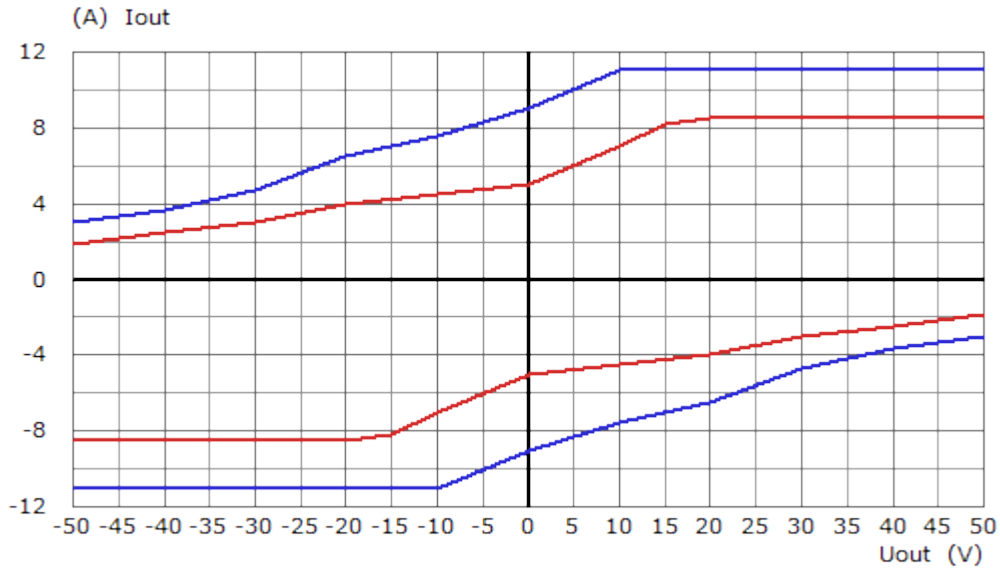

Output Current vs. Output Voltage (THD + N < 1%)
 Supply Voltage: High
 Blue: AC Limit
 Red: DC Limit

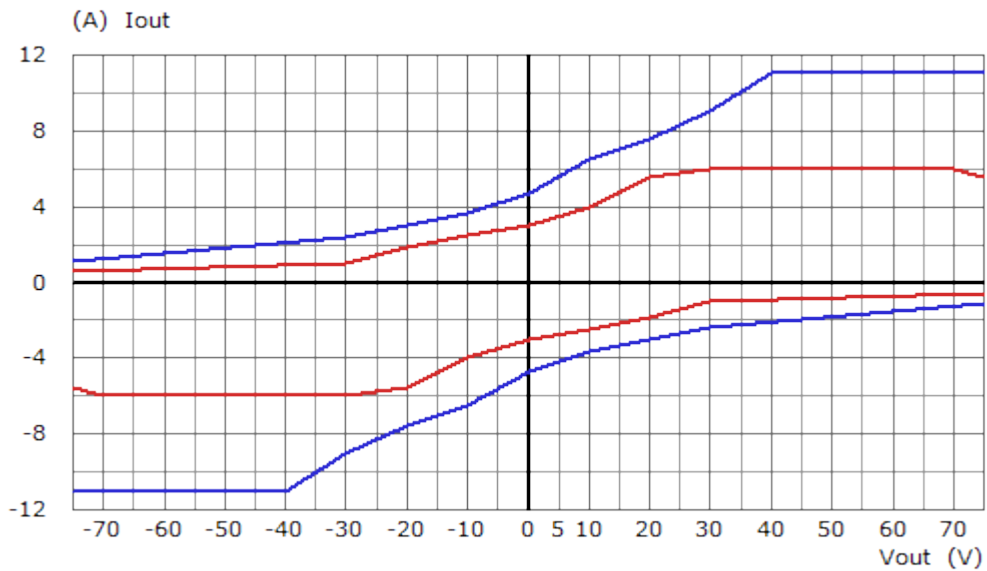

Square wave at 100 kHz and 10 Ohm load

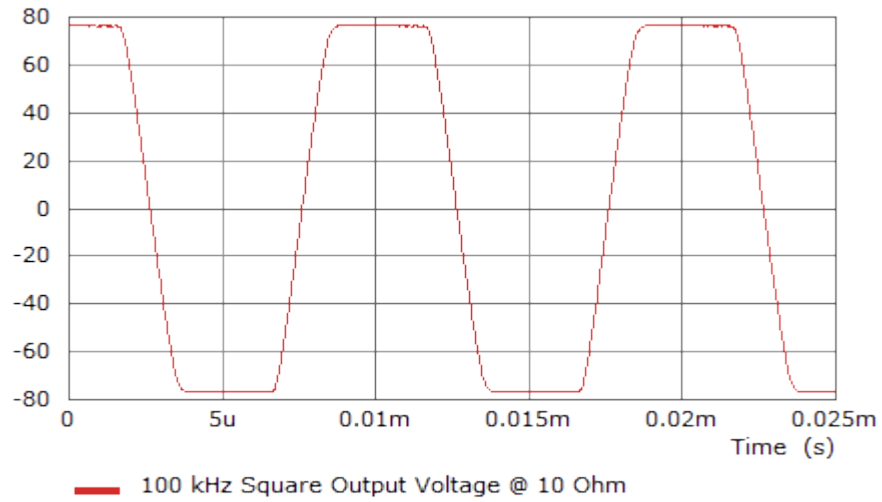

Power bandwidth at 10 Ohm load (Input level normalised to max. output level at 30 kHz; THD+N < 1%)

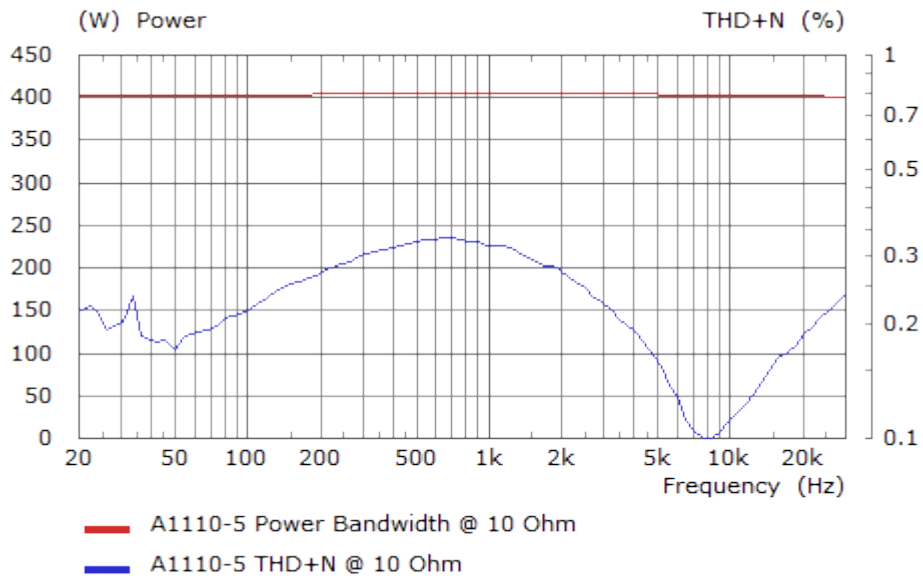

Power bandwidth at 4 Ohm load
 (Input level normalised to max. output level at 200 kHz; THD+N < 1%)

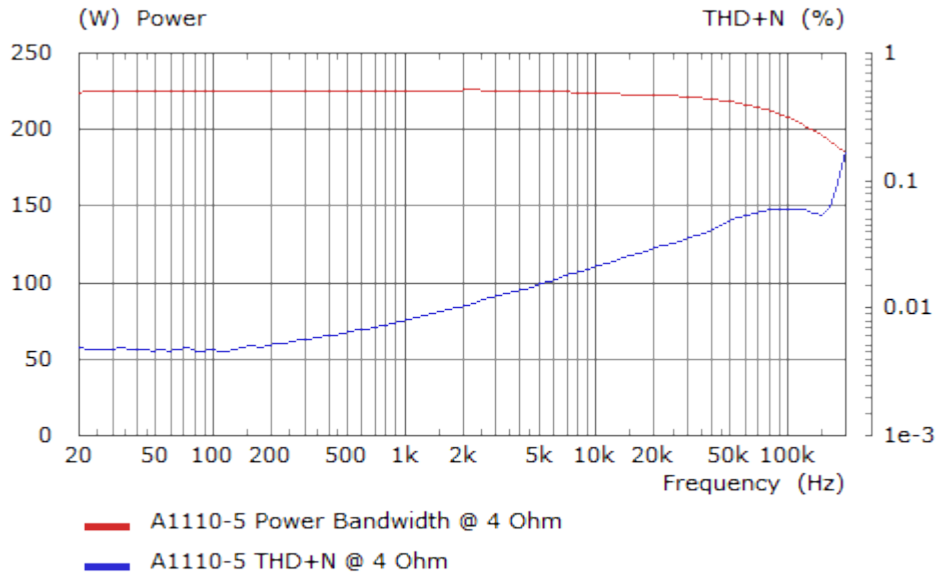

Pulse at 5 Ohm load

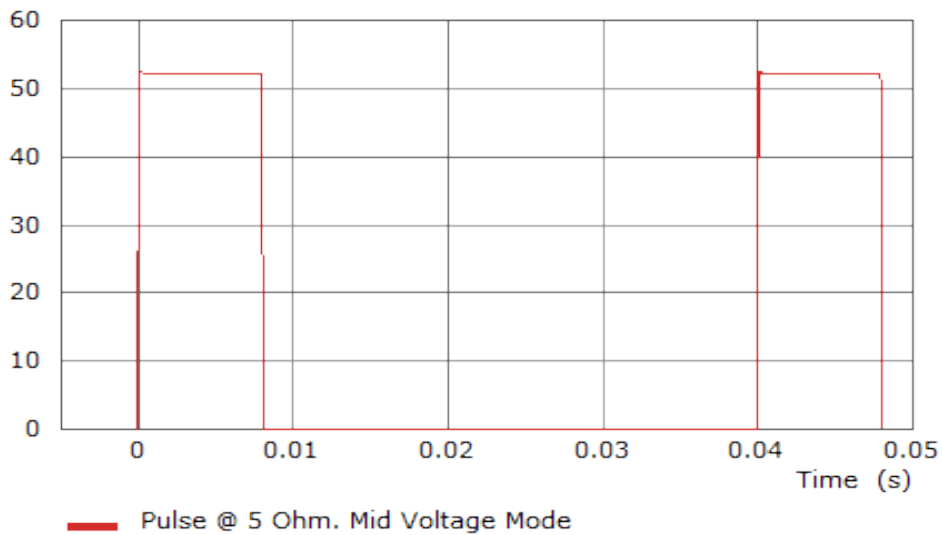

Output Impedance

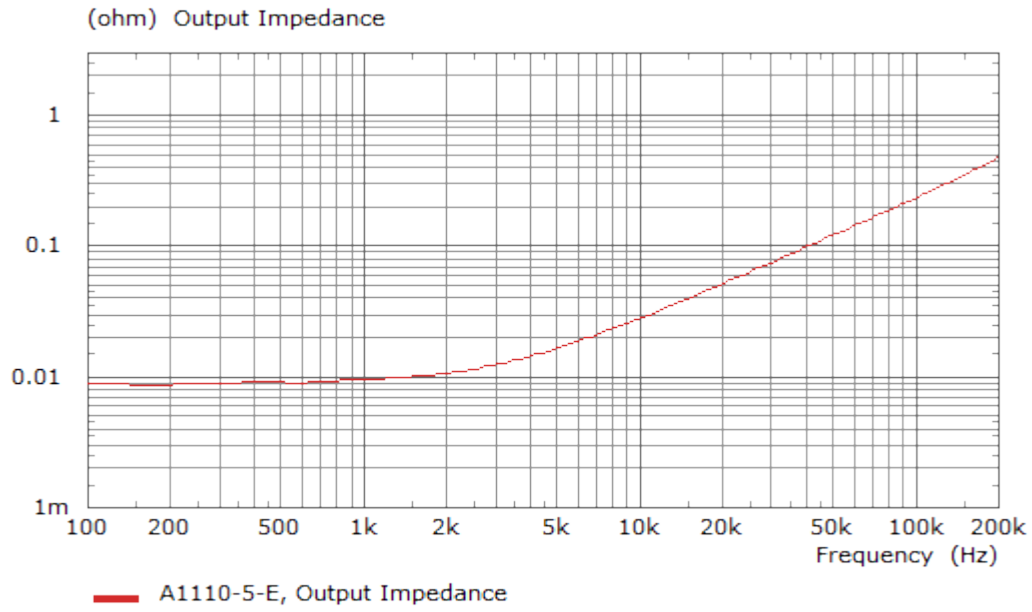

Block diagram A1110-05-E

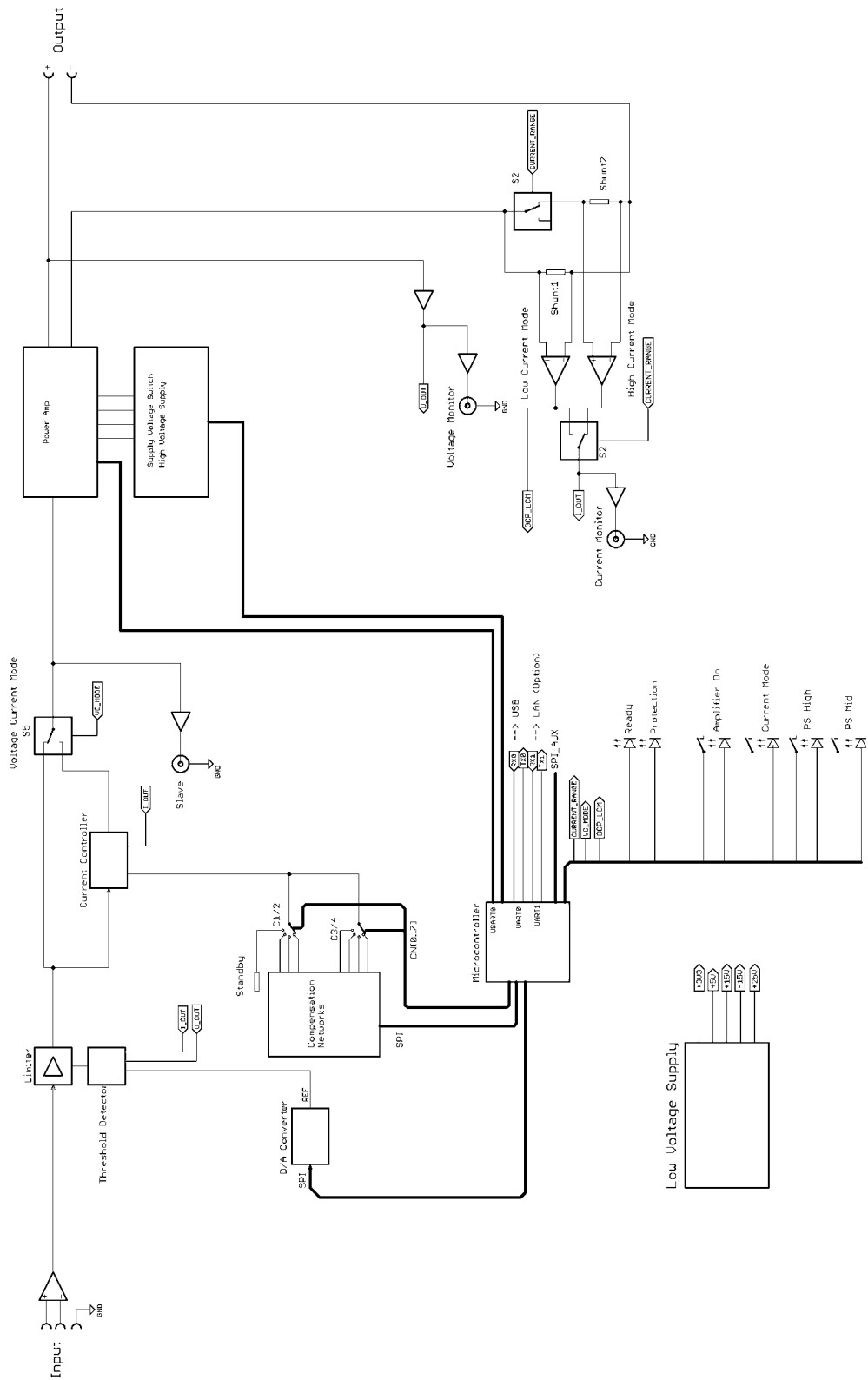

Ordering information

11100040	A1110-05-E; Precision power amplifier; incl. software
11101020	Option_02: Internal precision current measurement by means of high-performance current transformer 0-50A; Precision DC +/-0,1%; Bandwidth DC...>800kHz; Output BNC bush, galvanically isolated from the amplifier
11101030	Option_03: Ultra stable gain
11101040	Option_04: Function generator; DC, 0.05Hz - 300 kHz, sine, square, triangle
11101050	Option_05: Isolation amplifier for potential isolation of input and output
11101060	Option_06: Ethernet interface

Contact

Power4Test GmbH
Grünwalder Weg 13a
82008 Unterhaching
Germany

Tel.: +49 89 95890293
Fax: +49 89 95890295
Email: info@power4test.com
Web: www.power4test.com

